



Luxury Homes
ARCHITECTURE & INTERIORS

SOFAS

SILLONES | ARMCHAIRS

POUFFS

MESAS | TABLES

SILLAS | CHAIRS

COMEDORES | DINING TABLES

MUEBLES | FURNITURE

DORMITORIOS | BEDROOMS

ESPEJOS | MIRRORS

ALMOHADILLAS | PILLOWS

EXTERIOR | OUTDOOR

ALMOHADILLAS | PILLOWS



1290 POUFF
PAG. 156



1725 POUFF
PAG. 157



1734 POUFF
PAG. 158



1739 POUFF
PAG. 159



1743 POUFF
PAG. 160



1748 POUFF
PAG. 161



1749 POUFF
PAG. 162

1290

1290 POUFF

Pouff 1290 tapizado en piel Ascot C/814 Arena (S.17). Base barnizada en nogal natura (F1). Incorpora ruedas.

Mod.1290 wheeled pouff is upholstered in leather Ascot C/ 814 Arena (S.17). Base is varnished in natural walnut (F1).

1290

POUFF

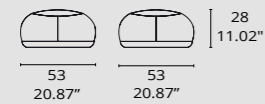

1725

1725 POUFF

Pouff 1725 (izqu.) base tapizada en piel sintética Premium 604 (S.3) y asiento en tela Mixology 3489 0408 (S.3).

Pouff 1725 (drcha.) con base tapizada en la tela Random C/01 (S.2) y asiento en tela Frozen Harmony CH2929/021 (S.3).

Pouff mod.1725 (left) is upholstered in simil leather Premium 604 (S.3) and seat in Mixology 3489 0408 (S.3).

Pouff mod.1725 (right) with base upholstered in Random C/01 (S.2) and seat in Frozen Harmony CH2929/021 (S.3).

1725

POUFF 92x92

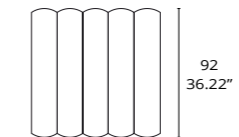
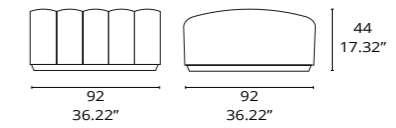

POUFF 125X92

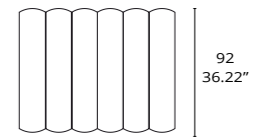
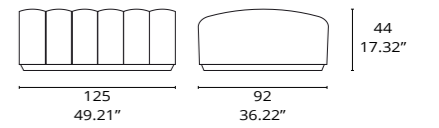

1734

1734 POUFF

Pouff 1734 tapizado en la piel Ascot Cobalto (S.17). Patas acabadas en marrón brillo (F5).

Pouff mod.1734 upholstered in leather Ascot Cobalto (S.17). The legs are lacquered in glossy brown (F5).

1734

POUFF

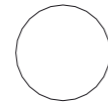
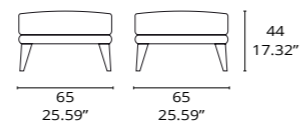

1739

1739 POUFF

Pouff 1739 tapizado en tela Pastel Poetry CH2829/024 (S.3) y zocalo en Texas C/5 (S.2).

Pouff mod.1739 upholstered in fabric Pastel Poetry CH2829/024 (S.3) with detail un Texas C/05 (S.2)

1739

POUFF

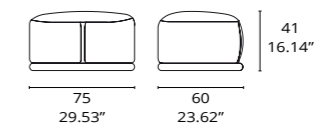

1743

1743 POUFF

Pouff 1743. Asiento tapizado en la telas Passion C/3 (S.4) e Intreccio C/3 (S.8). Patas lacadas en antracita brillo (F7)

Pouff mod.1743. Seat upholstered in Passion C/3 (S.4) and Intreccio C/3 (S.8). Legs are lacquered in glossy anthracite (F7).

1743

POUFF

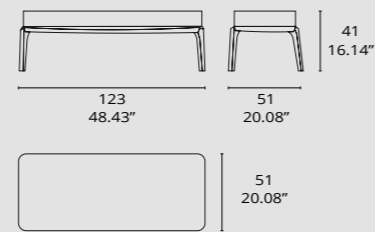

1748

1748 POUFF

Pouff 1748 con capitoné tapizado en la piel Nature C/1125 (S.12) y Ascot C/814 Arena (S.17).

Mod.1748 pouff with buttons upholstered in leather Nature C/1125 (S.12) and Ascot C/814 Arena (S.17).

1748

POUFF

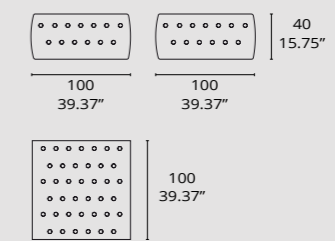

1749

1749 POUFF

Pouff giratorio 1749 tapizado en piel Dalmata C/91 (S.11) con cerco lacado en cobre brillo (F7). El giro del pouff es excentrico.

Pouff Mod.1749 upholstered in leather Dalmata C/91 (S.11) with swivel base in glossy copper (F7). The rotation of the pouff is eccentric.



1749

POUFF

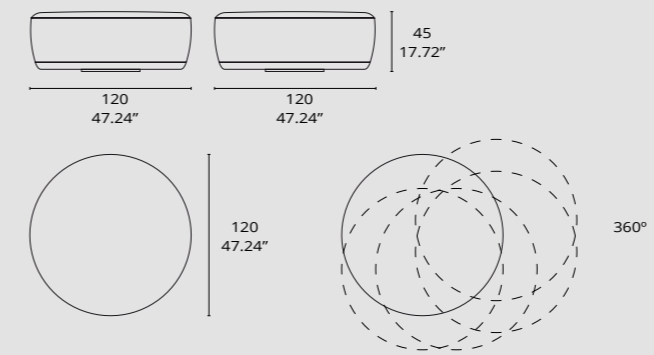

Notas de interés

Lh Arquitectura y Tecni Nova, s.l.u. dota de protección jurídica a sus creaciones, a través de la adquisición de derechos de Propiedad Industrial mediante la inclusión de sus productos en el Registro de los Dibujos y Modelos Industriales regulados en el Estatuto sobre Propiedad Industrial RDL 26 Julio de 1929 y el la Ley 11/1986 de 20 de Marzo de Patentes. Este sistema le permite ejercer sus derechos exclusivos sobre la fabricación, comercialización y difusión gráfica de sus registros y entablar cuantas acciones judiciales estime oportunas en defensa y contra el plagio que sobre sus modelos pudiese realizar cualquier tercero.

La empresa se reserva el derecho de hacer cualquier modificación sobre sus modelos, siempre que sea para mejora de los mismos.

Important notes

LH Arquitectura and Tecni Nova, s.l.u. provides judicial protection for its creations, through the acquisition of industrial property rights by means of the inclusion of this products in the Register of the desingns and industrial models regulated in the Statute on Industrial ownership Royal Decree Law, July 26, 1929 and Law 11/1986 dated March 20 of Patents. This system permits the exercising of exclusive rights of fabrication, commercialization and graphic dissemination of their records and to establish whatever judicial actions considered appropriate in defense of and against plagerism of their models that could be carried out by any third party.

The company reserves the right to make any modification to its mod els, on condition that this is in order to make improvements.



Spain

LH Arquitectura
C/ El Abeto 11. 46900 Torrent (Monte Real)
Valencia. Spain
email: lh@lharquitectura.com
phone: +34 960 061 914 - +34 656846700

China

16 Tiantaishan Road Wenzhou City
Zhejiang Province, China, 3250000

