



Luxury Homes  
ARCHITECTURE & INTERIORS



SOFAS

SILLONES | ARMCHAIRS

POUFFS

MESAS | TABLES

SILLAS | CHAIRS

**COMEDORES | DINING TABLES**

MUEBLES | FURNITURE

DORMITORIOS | BEDROOMS

ESPEJOS | MIRRORS

ALMOHADILLAS | PILLOWS

EXTERIOR | OUTDOOR

ALMOHADILLAS | PILLOWS



4215/8 COMEDOR | DINING TABLE  
PAG. 216



4221 COMEDOR | DINING TABLE  
PAG. 220



4221/8 COMEDOR | DINING TABLE  
PAG. 222



4230/8 COMEDOR | DINING TABLE  
PAG. 228

## 4215/8

4221/8 MESA DE COMEDOR | DINING TABLE

1730 SILLA | CHAIR

1725 BANCO MODULAR | MODULAR BENCH



**Mesa de comedor 4215/8** con tapa de cristal mármol Giallo white. Patas lacadas en negro satinado y plata. (F5). **Silla 1730** tapizada en la tela London C/867 (S.7) con patas lacadas en negro (F4). **Espejo 4218/17** tapizado en la tela Cool 1-3110-093 (S.7). **Banco modular 1725** con asiento tapizado en tela Rioja 03-30979 C/91 (S.2) y respaldo en tela Texas C/02 (S.2).

**Dining table mod.4215/8** with top marble glass giallo white and legs lacquered black and silver (F5). **Chair mod.1730** upholstered in fabric London C/867 (S.7) and legs lacquered in black (F4). **Mirror mod.4218/17** upholstered in fabric Cool 1-3110-093 (S.7). Modular bench mod.1725 with seat upholstered in fabric Rioja 03-30979 C/91 (S.2) and back in Texas C/02 (S.2).

# 4215/8

4221/8 MESA DE COMEDOR | DINING TABLE

1730 SILLA | CHAIR

**Mesa de comedor 4215/8** con tapa de cristal mármol Giallo white y patas lacadas en negro satinado y plata. (F5). **Silla 1730** tapizada en la tela London C/867 (S.7) acabada en negro mate(F1).

**Dining table mod.4215/8** with top marble glass giallo white and legs lacquered in black and silver (F5). **Chair mod.1730** upholstered in fabric London C/867 (S.7) and lacquered in black matt (F1).

4215/8

MESA DE COMEDOR | DINING TABLE

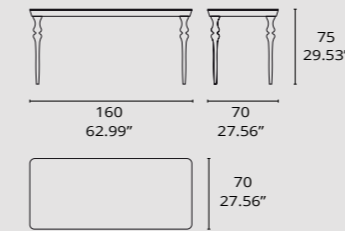



4221

4221/8 MESA DE COMEDOR | DINING TABLE  
 1743 SILLA | CHAIR  
 4221/14 APARADOR | SIDEBOARD  
 4220/10 ESPEJO | MIRROR  
 4220/7 MUEBLE TV | TV UNIT

**Mesa de comedor 4221/8** con estructura lacada en antracita brillo y tapa en nogal natura (F6). **Silla 1743** (negra) tapizada en tela y piel, con base tapizada en la piel Firenze Negro (S.11) con el logo bordado en la parte trasera. Respaldo y asiento tapizados en la tela Owen 9-2270-094 (S.4). Las patas están lacadas en antracita brillo (F7). **Silla 1743** (blanca) tapizada en tela y piel con base tapizada en la piel Firenze Pietra (S.11) con el logo bordado en la parte trasera. Respaldo y asiento tapizados en la tela Touch-me C/1 (S.7). Las patas están lacadas en antracita brillo (F7).

**Dining table mod.4221/8** lacquered in glossy anthracite and top in walnut nature (F6). **Chair mod.1743** (Black) upholstered in fabric and leather with base in Firenze Negro (S.11) and embroidered logo. Back and seat upholstered in Owen 9-2270-094 (S.4). Legs lacquered in glossy anthracite (F7). **Chair mod.1743** (White) with base upholstered in Firenze Pietra (S.11) and embroidered logo. Back and seat are upholstered in Touch-me C/1 (S.7). Legs lacquered in glossy anthracite (F7).

## 4221/8

4221/8 MESA DE COMEDOR | DINING TABLE  
1743 SILLA | CHAIR



**Mesa de comedor 4221/8** lacada en antracita brillo y tapa en nogal natura (F6). Base metálica de acero inoxidable. **Silla 1743** base tapizada en piel Firenze Negro (S.11) con el logo bordado en la parte trasera. Respaldo y asiento tapizados en la tela Owen 9-2270-094 (S.4) y patas lacadas en antracita brillo (F7). **Silla 1743** con base tapizada en la piel Firenze Pietra (S.11) con el logo bordado en la parte trasera. Respaldo y asiento tapizados en Touch-me C/1 (S.7) y patas lacadas en antracita brillo (F7).

**Dining table mod.4221/8** in glossy anthracite and walnut nature top (F6). Round base in stainless steel. **Chair mod.1743** (black) upholstered in fabric and leather with base Firenze Negro (S.11) with the embroidered logo. Back and seat upholstered in Owen 9-2270-094 (S.4). Legs lacquered in glossy anthracite (F7). **Chair mod.1743** (white) with base in Firenze Pietra (S.11) with embroidered logo. Back and seat upholstered in Touch-me C/1 (S.7). Legs lacquered in glossy anthracite (F7).

# 4221/8

**4221** MESA DE COMEDOR | DINING TABLE  
**1290** SILLA | CHAIR

**Mesa de comedor 4221/8** con patas lacadas en beige y tapa roble natura (F4)

**Silla 1290** tapizada en tela Next C/20 (S.3) y estructura barnizada en roble natura (F1).

**Dining table mod.4221/8** with legs lacquered in beige and top in oak in nature finish (F4). **Chair mod.1290** upholstered in fabric Next C/20 (S.3) and structure varnished in natural oak (F1).

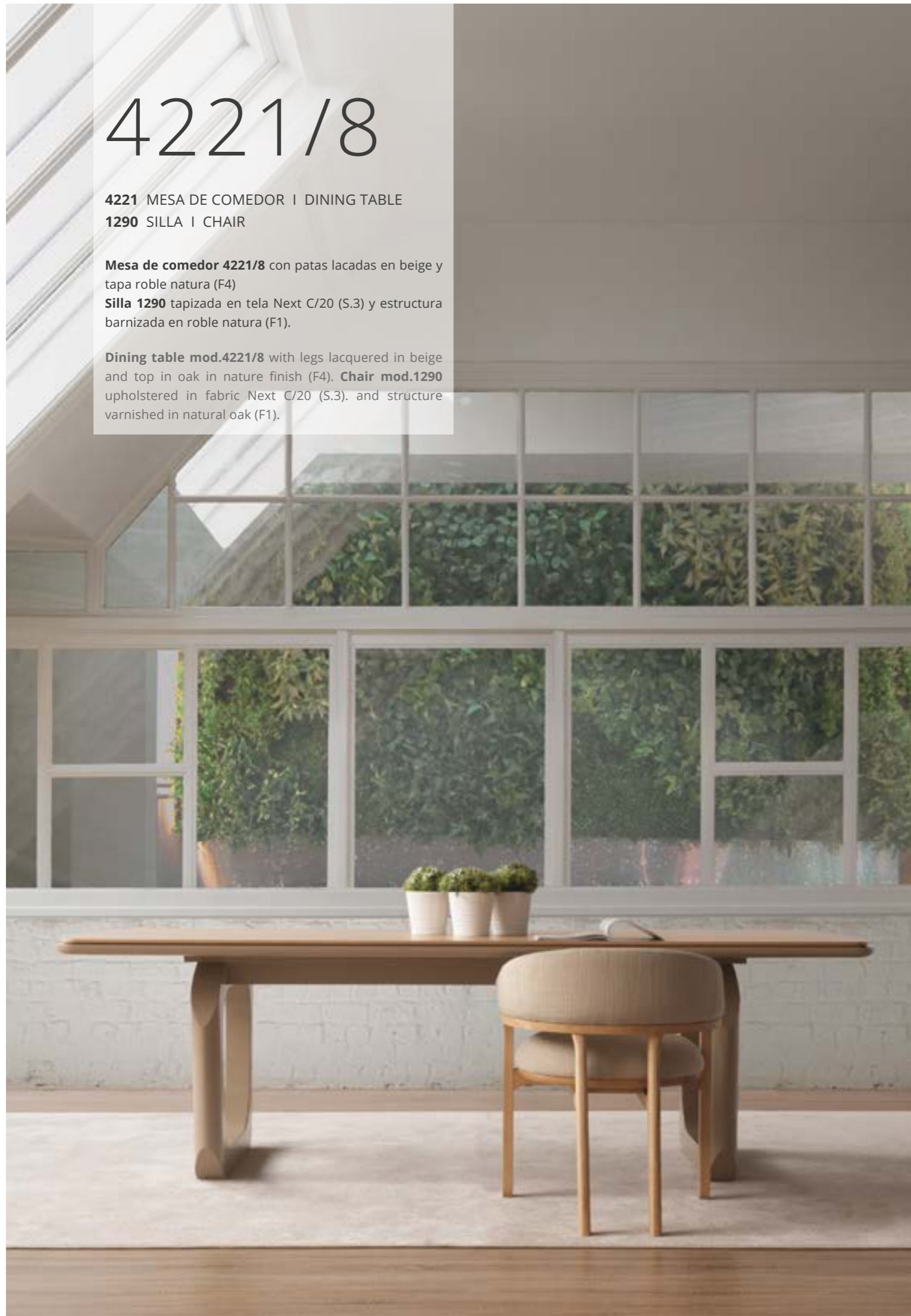

## 4221/8

4221/8 MESA DE COMEDOR | DINING TABLE

4221/8 MESA DE COMEDOR | DINING TABLE

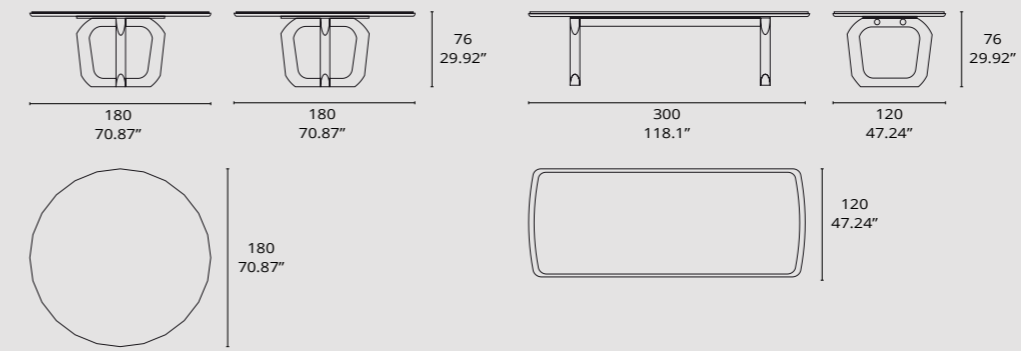



# 4230/81

4230/81 MESA DE COMEDOR | DINING TABLE  
1749 SILLÓN | ARMCHAIR



**Mesa de comedor 4230/81** con estructura de acero bañada en latón envejecido y tapa de madera lacada en latón (F8) y tapa de cristal 5+5 tintado en bronce. **Sillón giratorio 1749** tapizado en tela Beaux Z474/03 Affogato. (S.9) con base lacada en antracita brillo (F7).

**Table mod. 4230/81** with steel structure in old brass colour. Glass top in bronze colour 5+5, top lacquered in brass. **Swivel armchair mod.1749** upholstered in fabric Beaux Z474/03 Affogato (S.9). The base is lacquered in glossy antracithe (F7).

# 4230/81

**4230/81** MESA DE COMEDOR | DINING TABLE  
**1749** SILLÓN | ARMCHAIR



**Mesa de comedor 4230/81** con estructura de acero bañada en latón envejecido. Tapa de madera en oro patina brillo (F7) y cristal en bronce. **Sillón giratorio 1749** tapizado en tela Beaux Z474/03 Affogato (S.9) y base lacada en antracita brillo (F7).

**Table mod.4230/81** with steel structure in old brass colour. Glass top in bronze colour and wooden top in glossy gold patina (F7). **Swivel armchair mod.1749** upholstered in fabric Beaux Z474/03 Affogato (S.9) and base in glossy anthracite finish (F7).



## 4230/81

MESA DE COMEDOR | DINING TABLE 2.37CM

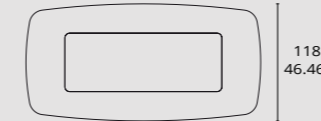
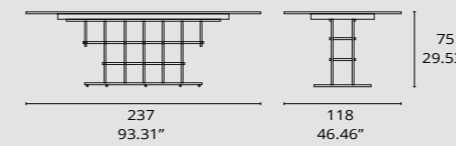

MESA DE COMEDOR | DINING TABLE 3.00 CM

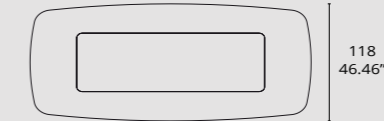
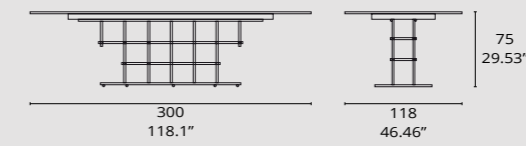

4230/9 CONSOLA  
 CONSOLE

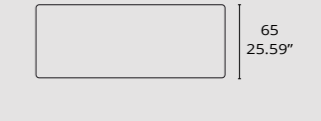
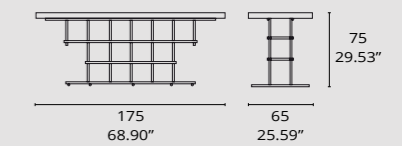

### Notas de interés

Lh Arquitectura y Tecni Nova, s.l.u. dota de protección jurídica a sus creaciones, a través de la adquisición de derechos de Propiedad Industrial mediante la inclusión de sus productos en el Registro de los Dibujos y Modelos Industriales regulados en el Estatuto sobre Propiedad Industrial RDL 26 Julio de 1929 y el la Ley 11/1986 de 20 de Marzo de Patentes. Este sistema le permite ejercer sus derechos exclusivos sobre la fabricación, comercialización y difusión gráfica de sus registros y entablar cuantas acciones judiciales estime oportunas en defensa y contra el plagio que sobre sus modelos pudiese realizar cualquier tercero.

La empresa se reserva el derecho de hacer cualquier modificación sobre sus modelos, siempre que sea para mejora de los mismos.

### Important notes

LH Arquitectura and Tecni Nova, s.l.u. provides judicial protection for its creations, through the acquisition of industrial property rights by means of the inclusion of this products in the Register of the desingns and industrial models regulated in the Statute on Industrial ownership Royal Decree Law, July 26, 1929 and Law 11/1986 dated March 20 of Patents. This system permits the exercising of exclusive rights of fabrication, commercialization and graphic dissemination of their records and to establish whatever judicial actions considered appropriate in defense of and against plagerism of their models that could be carried out by any third party.

The company reserves the right to make any modification to its mod els, on condition that this is in order to make improvements.



**Spain**

LH Arquitectura  
C/ El Abeto 11. 46900 Torrent (Monte Real)  
Valencia. Spain  
email: lh@lharquitectura.com  
phone: +34 960 061 914 - +34 656846700

**China**

16 Tiantaishan Road Wenzhou City  
Zhejiang Province, China, 3250000

